

56.03511 MINI Recessed Downlight-Adjust

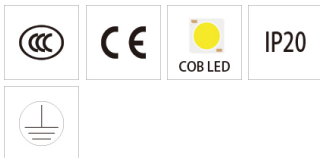
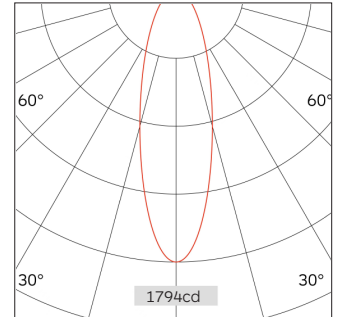
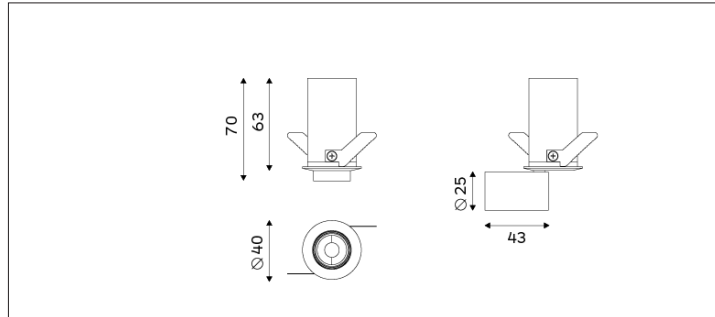

Light Distribution	MINI Recessed Downlight
Colour Temperature	2700/3000/3500/4000K
Colour Rendition Index	CRI 90
Optics	LENS
Beam Angle	20D/26D/38D/56D
Cut Out	35mm
Connected Load	4W
Luminous Flux Of The Luminaire	301lm
Luminaire Efficacy	60lm/W
Colour Deviation	SDCM <5
Light Source	LED
LED Type	COB
Dimming Method	Triac/1-10V/ Dali
Cover Material	Aluminum
Body Material	Aluminum
IP Rating	IP20
Housing Colour	Sandy White/ Sandy Black
Weight	0.3Kg
Technical Region	220-240V 50/60Hz

Light Beam Talbe		
h(m)	E(lx)	D(m)
		20°
1.0	1794	0.36
2.0	448	0.71
3.0	199	1.07
4.0	112	1.43
5.0	71	1.78

Application areas: High end residential and retail projects, hotels, museums and galleries.