

56.03513 FOS Recessed Downlight

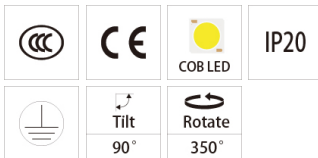
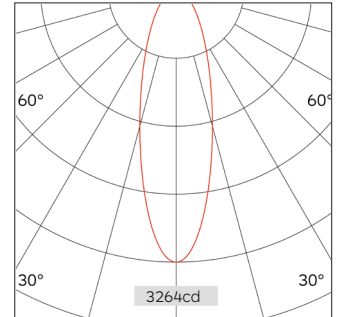
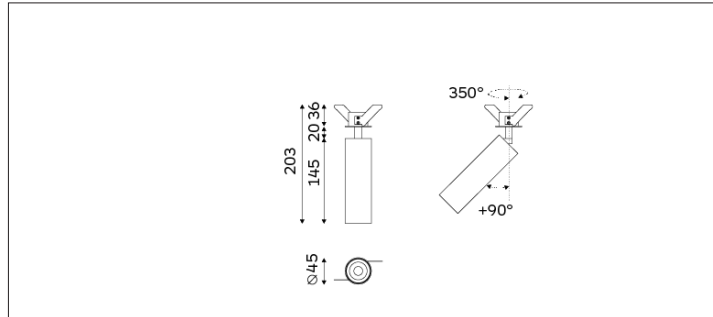

Light Distribution	FOS Recessed Downlight
Colour Temperature	2700/3000/3500/4000K
Colour Rendition Index	CRI 90
Optics	LENS
Beam Angle	18D/22D/32D/45D
Cut Out	35mm
Connected Load	10W
Luminous Flux Of The Luminaire	617lm
Luminaire Efficacy	64m/W
Colour Deviation	SDCM <5
Light Source	LED
LED Type	COB
Dimming Method	Triac/1-10V/ Dali
Cover Material	Aluminum
Body Material	Aluminum
IP Rating	IP20
Housing Colour	Sandy White/ Sandy Black
Weight	0.35Kg
Technical Region	220-240V 50/60Hz

Light Beam Talbe		
h(m)	E(lx)	D(m)
		22°
1.0	3264	0.40
2.0	816	0.80
3.0	363	1.20
4.0	204	1.60
5.0	130	2.80

Application areas: retail, museums, hospitality, residential, offices and lobbies.