

52.03513 MINI Recessed Downlight-Adjust

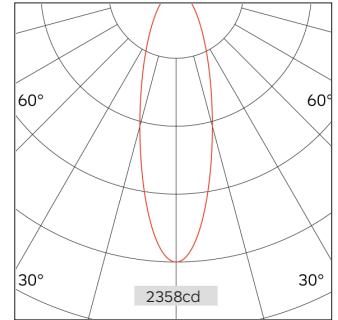
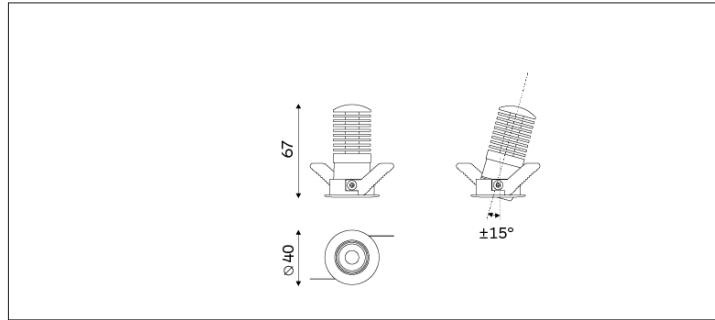

Light Distribution	MINI Recessed Downlight
Colour Temperature	2700/3000/3500/4000K
Colour Rendition Index	CRI 90
Optics	LENS
Beam Angle	20D/24D/39D/51D
Cut Out	35mm
Connected Load	6.5W
Luminous Flux Of The Luminaire	432lm
Luminaire Efficacy	67lm/W
Colour Deviation	SDCM <5
Light Source	LED
LED Type	COB
Dimming Method	Triac/1-10V/ Dali
Cover Material	Aluminum
Body Material	Aluminum
IP Rating	IP20
Housing Colour	Sandy White/ Sandy Black
Weight	0.2Kg
Technical Region	220-240V 50/60Hz

Light Beam Talbe		
h(m)	E(lx)	D(m)
		20°
1.0	2358	0.35
2.0	589	0.71
3.0	262	1.06
4.0	147	1.41
5.0	94	1.76

Application areas: High end residential and retail projects, hotels, museums and galleries.